

Single Sliding Quadrant shower Enclosure

FITTING INSTRUCTIONS

NQ80S, NQ90S, NQ10S

IMPORTANT CHECK LIST

PLEASE ENSURE

- The walls are reasonably flat and that the shower tray is level
- There is no pipe work or cables behind walls where drilling
- Shower door is correct size door for tray (see measurements below)
- Shower base is level and secure and sealed correctly(bottom profile sealed on outside only)
- There is no visual defect on door (as claim will no be accepted after installation)
- Proper fixings used if cavity wall or other

TRAY Size	Dimensions A Min-Max	Dimensions B Min-Max
800*800	755-795	755-795
800*900	755-795	855-895
900*900	855-895	855-895
800*1000	755-795	955-995
1000*1000	955-995	955-995
800*1200	755-795	1155-1195
900*1200	855-895	1155-1195

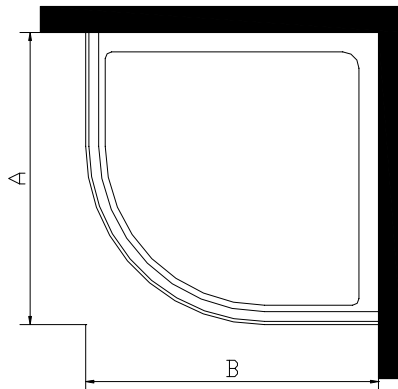

INSTRUCTION MANUAL

Inspect door after opening

Please read instructions carefully, check amount of accessories and whether the shower door is in good condition and if there are any problems contact your supplier or our company.

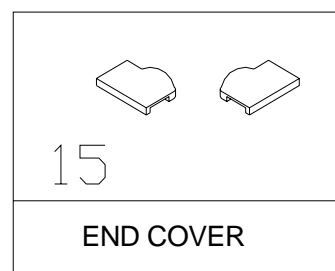
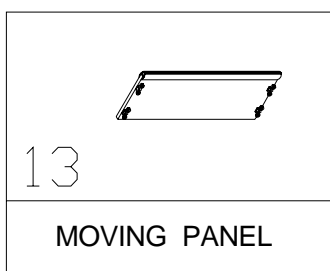
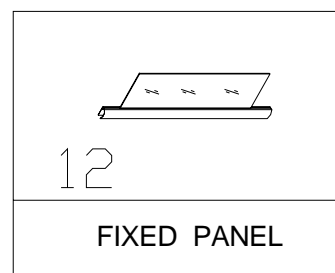
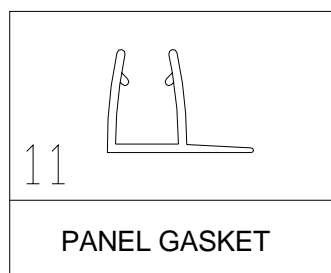
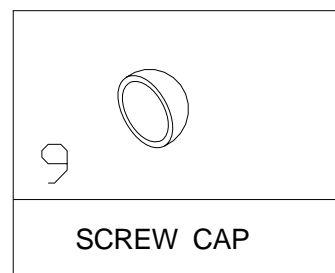
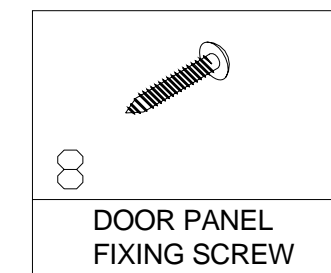
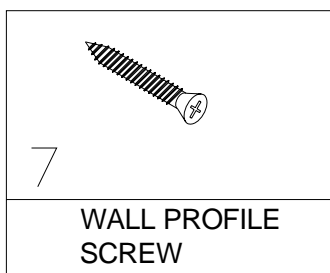
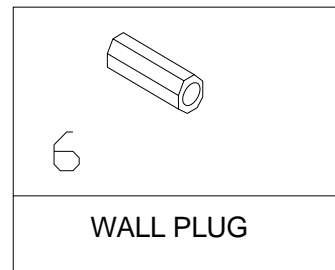
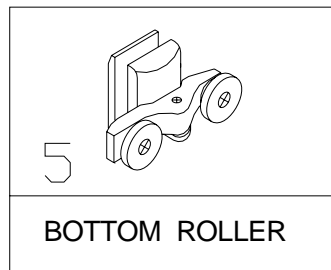
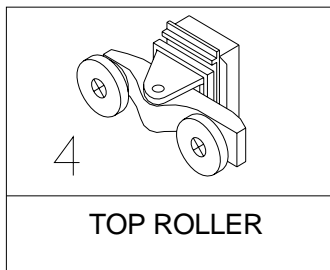
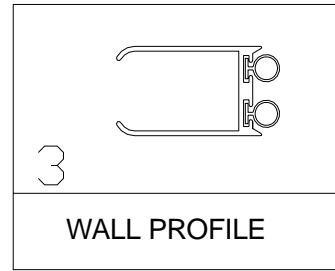
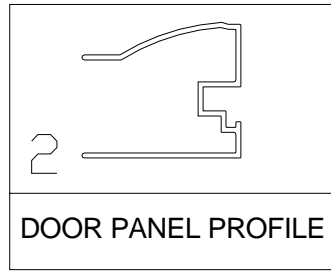
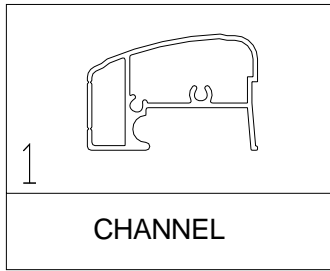

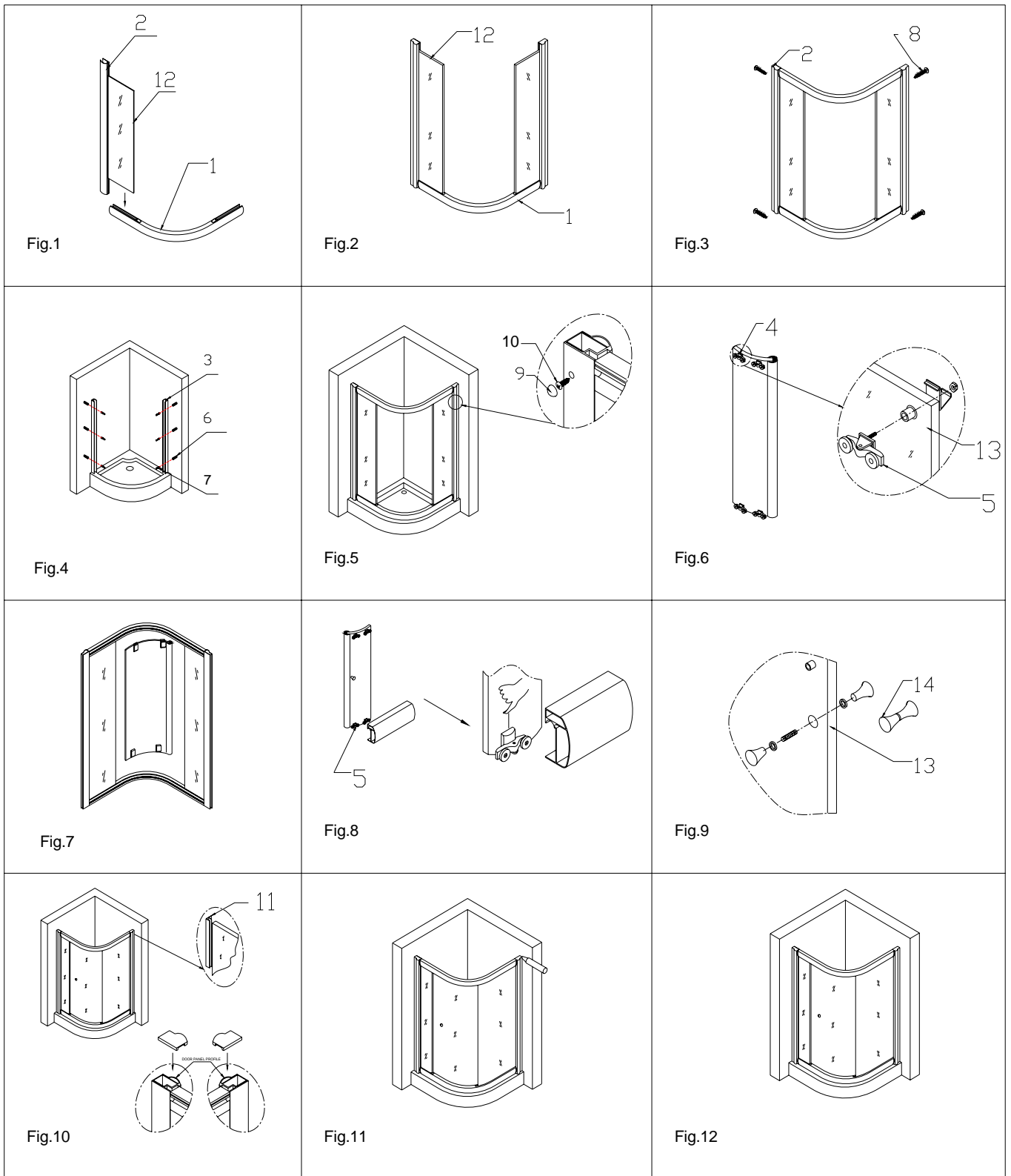

- 1、 Install wall profiles level in upright position using screws No. 7 (see Fig. 4)
- 2、 Build frame by attaching top and bottom profiles (No. 1) to fixed panels (No. 12) using fixing screws supplied(No. 8) securely on each corner make sure gaskets are fully inserted and pushed home as not fully inserted will result in doors not clip into position (see Fig. 3)
- 3、 Hang doors from top profile using adjustment to check for initial smooth running(No. 13), remove to fix frame to wall profiles (doors can be reinstalled after frame is secured)

- 4、 Fix frame to wall profiles using screws on inside (see Fig. 5)
- 5、 Fix handles (No.14) to doors (Fig. 9)
- 6 、 Hang doors onto frame and adjust for smooth running
- 7、 Seal door on outside only (wall and between tray) to ensure watertight seal

Adjustment

All doors are designed to run correctly, if this does not occur please revert to point no 2
 Make sure gaskets are fully slotted in or use hex nuts on back of top roller to get adjustment.

