

# MATRIX

## QUADRANT SHOWER DOOR FITTING INSTRUCTIONS NQ80, NQ90, NQ10, NQ2T IMPORTANT CHECK LIST PLEASE ENSURE

The walls are reasonable flat and that the shower tray is levelled  
 There is no pipework or cables behind walls where drilling  
 Shower door is correct size door for tray(see measurements below)  
 Shower base is level and secure and sealed correctly(bottom profile sealed on outside only)  
 There is no visual defect on door(as claim will not be accepted after installation)  
 Proper fixings used if cavity wall or other

TRAY Size	Dimensions A Min-Max	Dimensions B Min-Max
800*800	770-795	770-795
800*900	770-795	870-895
900*900	870-895	870-895
800*1000	770-795	970-995
1000*1000	970-995	970-995
800*1200	770-795	1170-1195
900*1200	870-895	1170-1195

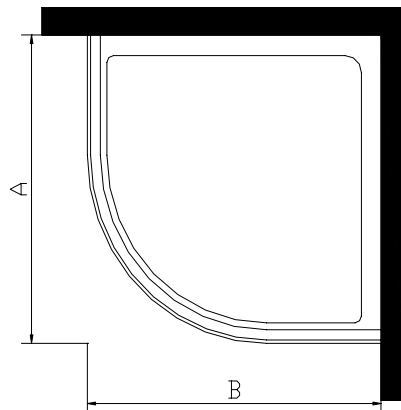

Inspect door after opening

Please read instructions carefully, check amount of accessories and whether the shower door is in good condition and if there are any problems contact your supplier or our company.

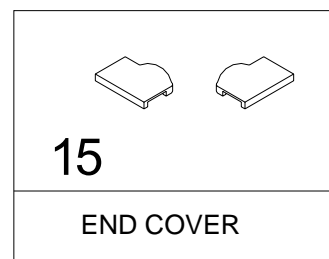
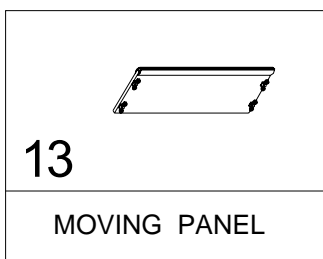
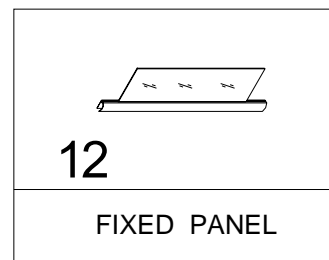
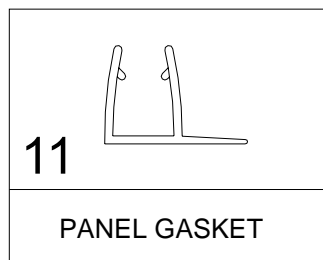
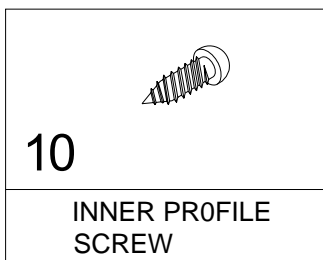
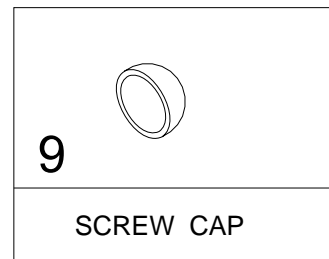
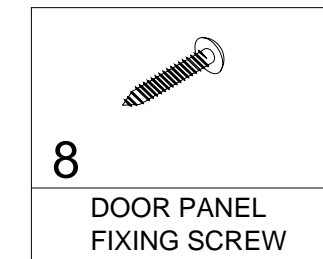
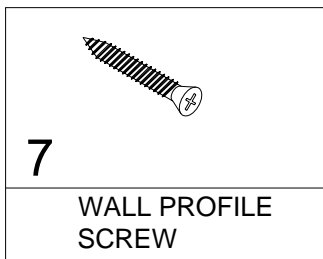
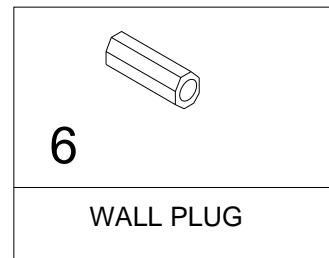
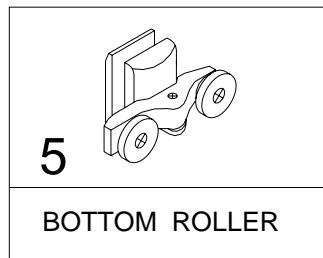
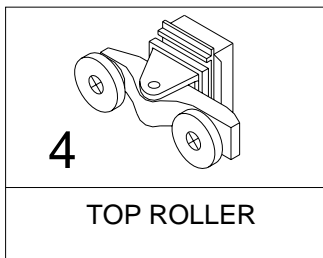
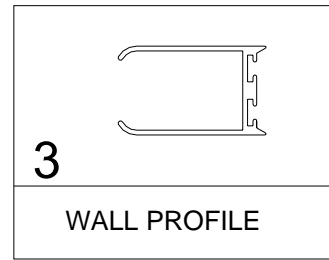
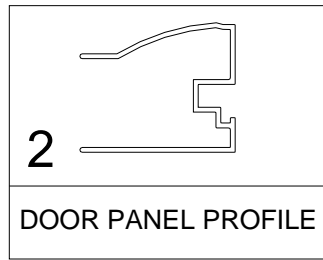
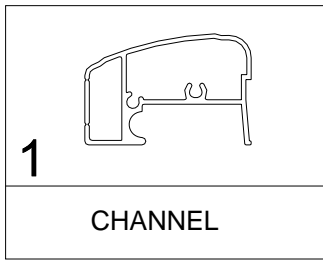

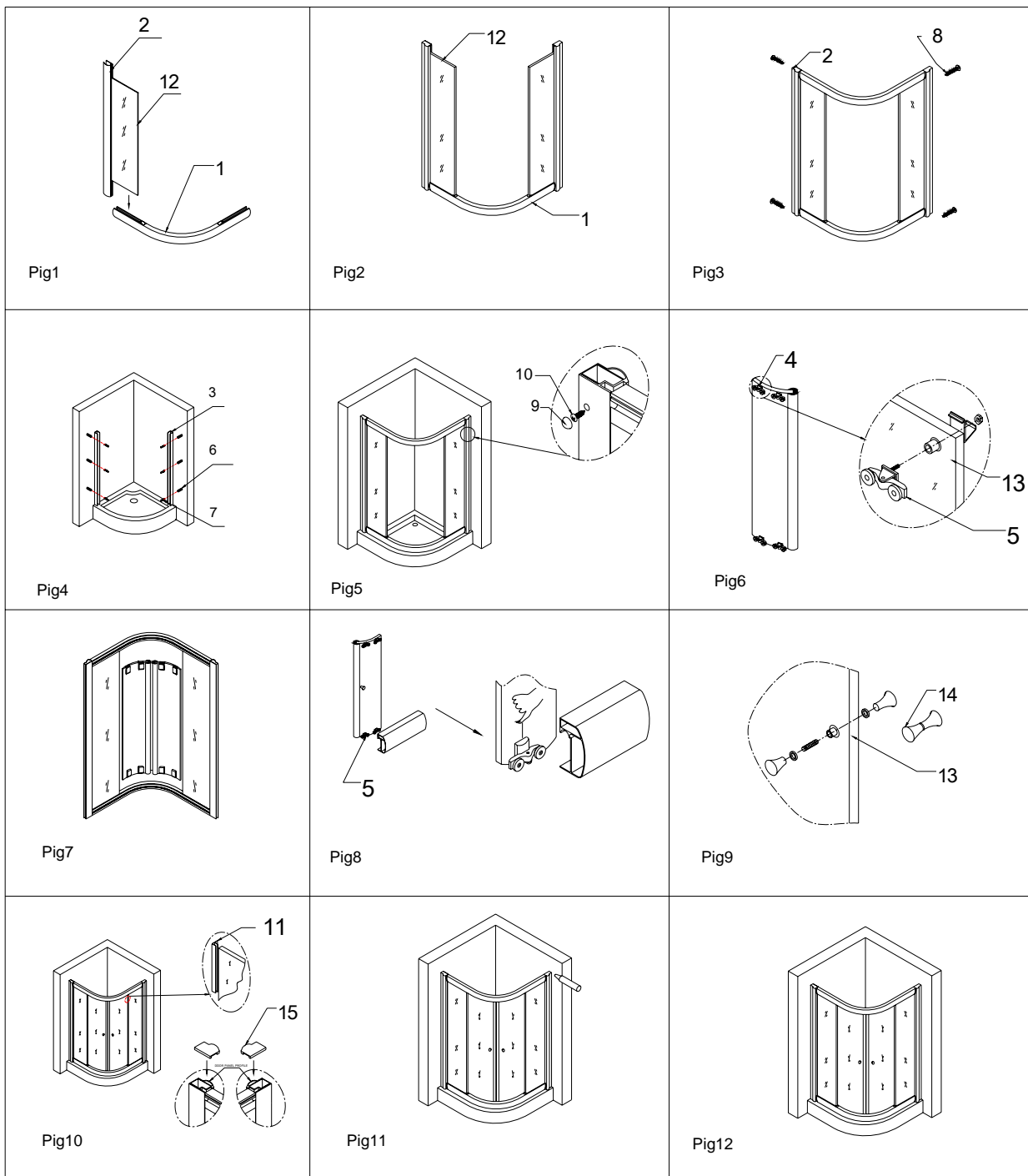

- 1、 Install wall profiles level in upright position using screws No. 7 (see Fig. 4)
- 2、 Build frame by attaching top and bottom profiles (No. 1) to fixed panels (No. 12) using fixing screws supplied(No. 8) securely on each corner make sure gaskets are fully inserted and pushed home as not fully inserted will result in doors not clipping into position (see Fig. 3)
- 3、 Hang doors from top profile using adjustment to check for enitial smooth running(No. 13), remove to fix frame to wall profiles(doors can be reinstalled after frame is secured)
- 4、 Fix frame to wall profiles using screws on inside (see Fig. 5)
- 5、 Fix handles (No.14) to doors (Fig. 9)

6 、 Hang doors onto frame and adjust for smooth running

7、 Seal door on outside only (wall and between tray) to ensure watertight seal

## Adjustment

All doors are designed to run correctly , If this does not occur please revert to point no 2  
Make sure gaskets are fully slotted in or use hex nuts on back of top roller to get adjustment.

