

MATRIX

Deluxe Walk In Shower Enclosure FITTING INSTRUCTIONS 12x9WK

IMPORTANT CHECK LIST

PLEASE ENSURE

- The walls are reasonably flat and that the shower tray is level
- There is no pipe work or cables behind walls where drilling
- Shower door is correct size door for tray (see measurements below)
- Shower base is level and secure and sealed correctly (bottom profile sealed on outside only)
- There is no visual defect on door (as claim will not be accepted after installation)
- Proper fixings used if cavity wall or other

TRAY Size	Dimensions A Min-Max	Dimensions B Min-Max
900*1200	870-895	1170-1195

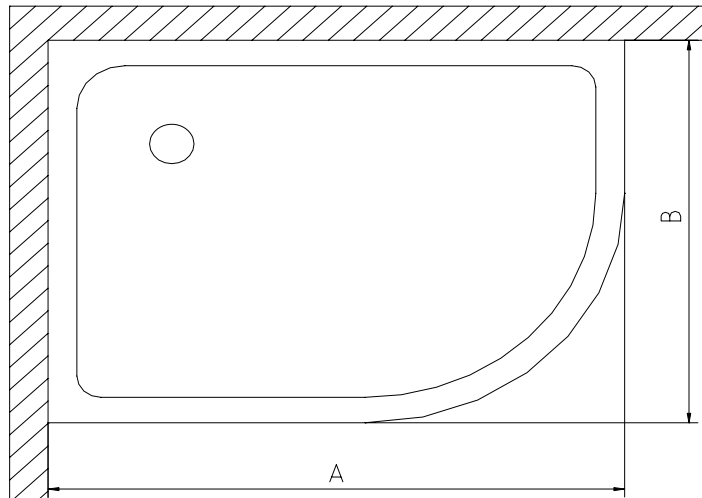

Inspect door after opening

Please read instructions carefully, check amount of accessories and whether the shower door is in good condition and if there are any problems contact your supplier or our company.

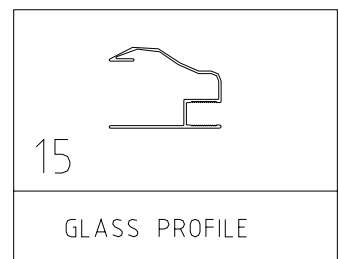
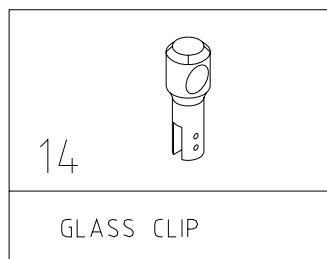
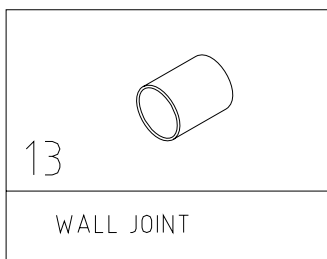
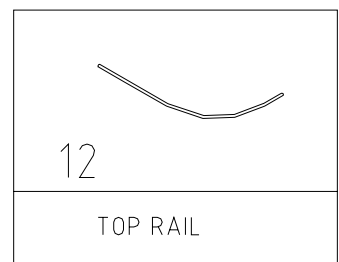
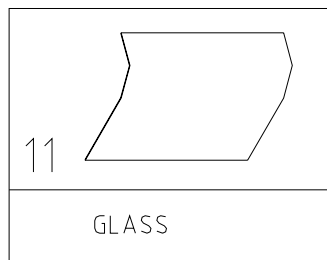
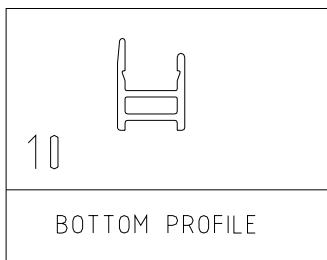
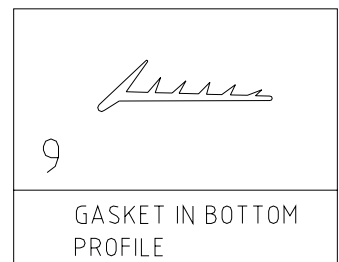
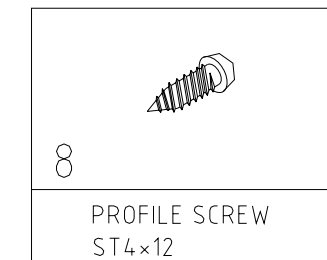
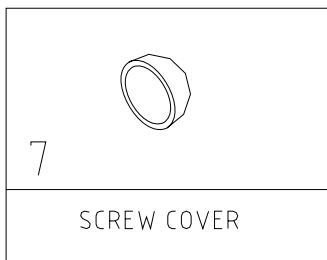
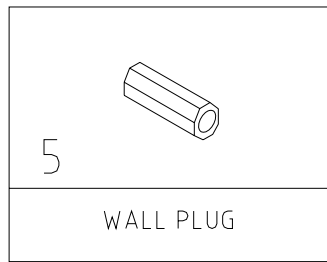
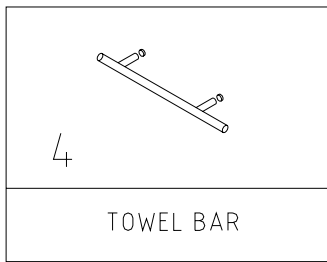
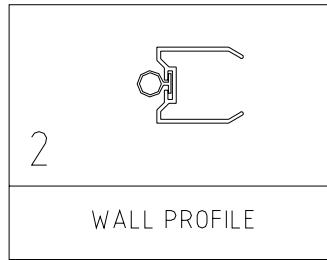
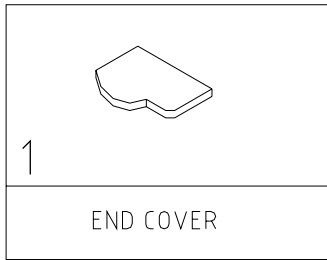

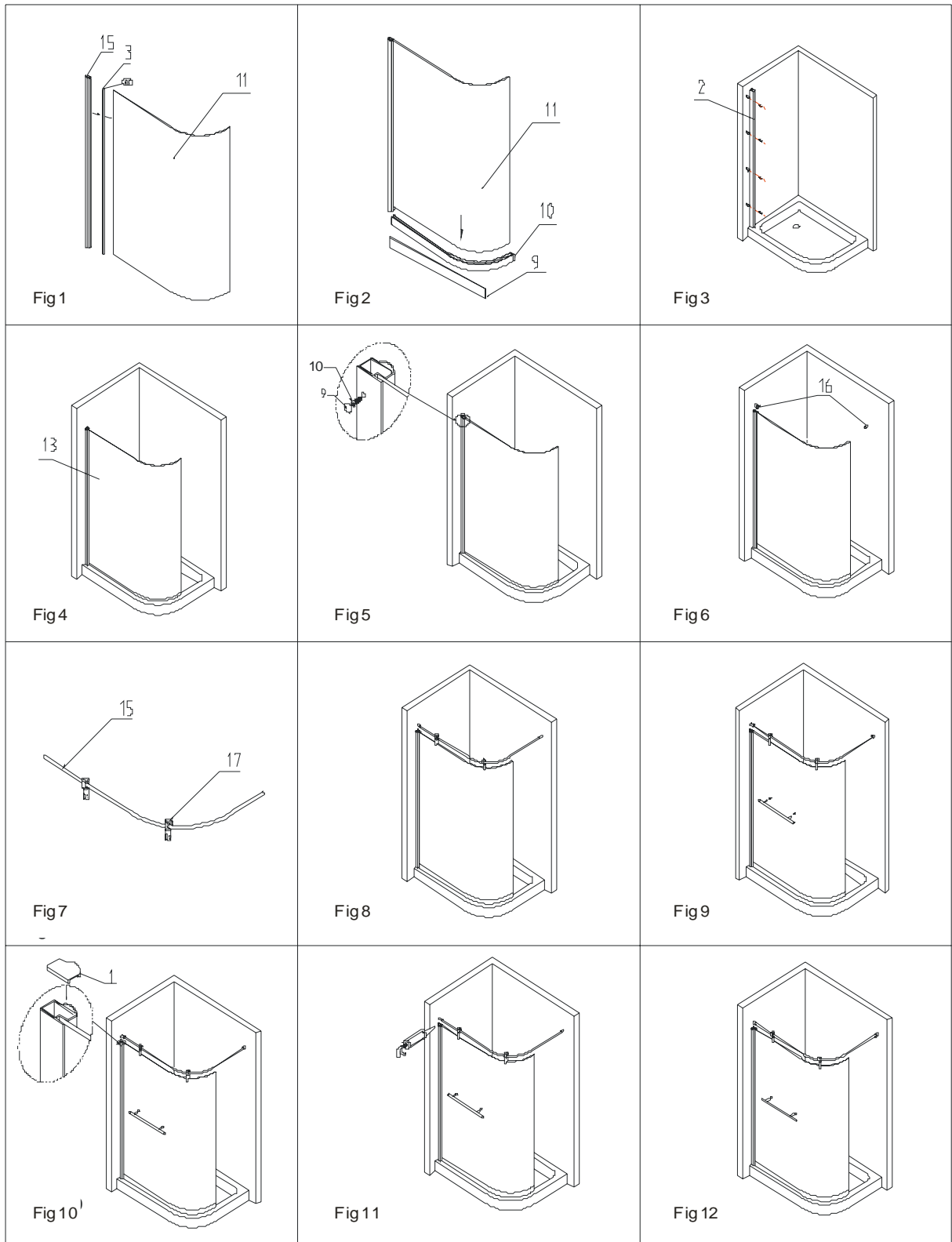

- 1、 Install wall profiles level in upright position using screws No. 6 (see Fig. 3)
- 2、 Attach glass profile (No.15) to glass panel (No. 11) using gasket between profile and glass (No.3) (see Fig. 1)

- 3、 Attach bottom profile (No.10) to glass panel, using gasket in bottom profile (No.9) (see Fig.2)
- 4、 Fix the glass with profiles onto the wall profile (see Fig. 4)
- 5、 Fix glass profile to wall profile using screws No.8 on inside (see Fig. 5)
- 6、 Put the glass clips onto the top rail. Fix the two ends of the top rail to the wall with two wall joints No. 13 (Fig. 8)
- 7、 Fix the handle No.4 (see Fig.9). Put the end cover onto the top of the profile (see Fig.10)
- 8、 Seal door on outside only (wall and between tray) to ensure watertight seal

